













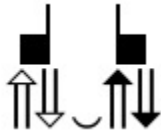



# Lengua de señas argentina; LSA

Spoken Word	SignWriting
?	
A	
a-cuadros	
a-favor	
a-si-mismo	
a-veces	
a-veces	
abrir	
abrojo	
abstracción	





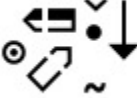

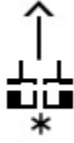

# Lengua de señas argentina; LSA

Spoken Word	SignWriting
absurdo	<p>The signwriting for 'absurdo' consists of a face with a flat top and a wide, open mouth. Below the mouth is a symbol resembling a stylized 'S' or a similar shape. To the right of the face are two asterisks (**).</p>
abuelo	<p>The signwriting for 'abuelo' features a large circle on the left. To its right is a symbol with two small circles above a wavy line, and a square below. To the right of this symbol is an upward-pointing arrow.</p>
abuelo	<p>The signwriting for 'abuelo' includes a large circle on the left. To its right is a symbol with three asterisks (***) above a wavy line, and a hand-like shape below. To the right of this symbol is an upward-pointing arrow.</p>
abuelo	<p>The signwriting for 'abuelo' shows a large circle on the left. To its right is a symbol with a wavy line above a hand-like shape. To the right of this symbol is an upward-pointing arrow.</p>
abuelo	<p>The signwriting for 'abuelo' features a large circle on the left. To its right is a symbol with a wavy line above a hand-like shape. To the right of this symbol is an upward-pointing arrow.</p>
abuelo	<p>The signwriting for 'abuelo' includes a large circle on the left. To its right is a symbol with three asterisks (***) above a wavy line, and a hand-like shape below. To the right of this symbol is an upward-pointing arrow.</p>
aburrido	<p>The signwriting for 'aburrido' features a face with a flat top and a wide, open mouth. Below the mouth is a horizontal line. Below this line are two horizontal lines, each with a small triangle pointing upwards. To the left and right of these lines are curved arrows pointing outwards.</p>
aburrido	<p>The signwriting for 'aburrido' includes a face with a flat top and a wide, open mouth. Below the mouth is a horizontal line. Below this line are two horizontal lines, each with a small triangle pointing upwards. To the left and right of these lines are curved arrows pointing outwards.</p>









# Lengua de señas argentina; LSA

Spoken Word	SignWriting
aburrido	
aburrimiento	
abuso	
academia	
acción	
aceptar	
aceptar	
acidez	





# Lengua de señas argentina; LSA

Spoken Word	SignWriting
acompañar	
acordar	
acostumbrado	
acrónimo	
actriz	
acuerdo	
adelante	
adicción	
Adidas	





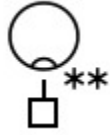
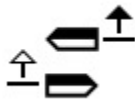

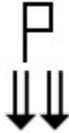
# Lengua de señas argentina; LSA

Spoken Word	SignWriting
adoptivo	
afasia	
afección	
afección	
aflojar	
afuera	
afuera	
afuera	

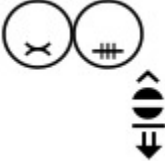
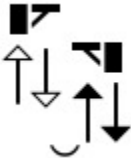







# Lengua de señas argentina; LSA

Spoken Word	SignWriting
Agosto	
agrandado	
agricultura	
agrónomo	
agua	
aguinaldo	
aguinaldo	
ahijado	
ahora	

# Lengua de señas argentina; LSA



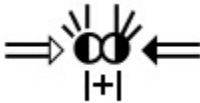



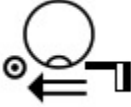

Spoken Word	SignWriting
ahorrar	
ahí	
ajedrez	
ajuste	
al frente	
al lado	
Alaska	
albañil	
alcanza	

# Lengua de señas argentina; LSA

Spoken Word	SignWriting
alegrar	
alegría	
Alemania	
alergia	
alfajor	
algo	
algodón	
alianza	
allá	
allá	









# Lengua de señas argentina; LSA

Spoken Word	SignWriting
alma	
almacén	
almanaque	
almanaque	
alquilar	
alquiler	
Alta Gracia	
alto	
alto	



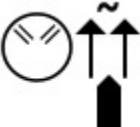

# Lengua de señas argentina; LSA

Spoken Word	SignWriting
alumno	<p>The signwriting for 'alumno' consists of a horizontal line above a vertical line with a downward arrow at its base.</p>
alumno-PL	<p>The signwriting for 'alumno-PL' consists of three vertical lines, each with a downward arrow at its base, arranged horizontally.</p>
amable	<p>The signwriting for 'amable' features a circle with two asterisks on either side, a horizontal line below it, and a curved arrow pointing downwards from the center.</p>
amante	<p>The signwriting for 'amante' includes a horizontal line with a circle containing an '@' symbol above it, two solid squares on either side, and a series of arrows below: down, up, down, up, up, down.</p>
amar	<p>The signwriting for 'amar' shows a smiley face above a horizontal line, which is above a house-like shape with a circular arrow to its right.</p>
amar	<p>The signwriting for 'amar' features a smiley face above a horizontal line, which is above a house-like shape with a circular arrow to its right and an upward arrow below it.</p>
amargo	<p>The signwriting for 'amargo' shows a sad face above a horizontal line, which is above a house-like shape with a circular arrow to its right and a wavy arrow below it.</p>





# Lengua de señas argentina; LSA

Spoken Word	SignWriting
amargo	
amargo	
amarillo	
amasar	
amenaza	
amenazar-1S-SG	
amenazar-SG-1S	
americano	

# Lengua de señas argentina; LSA

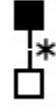
Spoken Word	SignWriting
amigo	
amigo	
amistoso	
amoroso	
América	

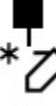

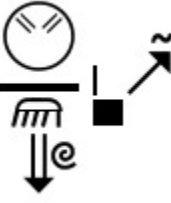
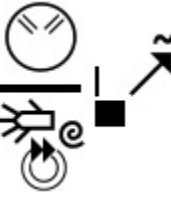
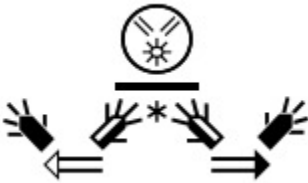
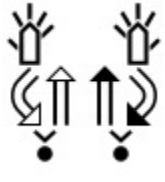





# Lengua de señas argentina; LSA

Spoken Word	SignWriting
América Central	
América del Norte	
América del Sur	
animal	
animar-1S-NEG	
animar-1S-NEG	
animar-1S-NEG-EXCL	
aniversario	
anoche	



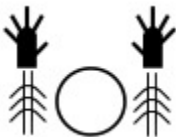
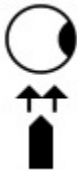



# Lengua de señas argentina; LSA

Spoken Word	SignWriting
anteayer	
antes	
antes	
antipático	
Antártida	
anual	
anual	
análisis	
análisis-de-sangre	

# Lengua de señas argentina; LSA



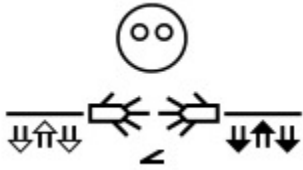

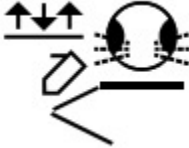



Spoken Word	SignWriting
aparecer	
aparecer	
aparecer	
apellido	
aplauzo	
apodo	
aporte	
aporte	
aporte	

# Lengua de señas argentina; LSA

Spoken Word	SignWriting
aprender	
aprender	
aprender	
aprobación	
aprobación	
apuro	
aquel	
aquí	
ardor	

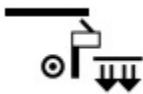

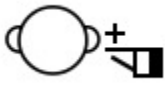



# Lengua de señas argentina; LSA

Spoken Word	SignWriting
arena	
Argentina	
Argentina	
Argentina	
argentina	
Argüello	
armario	
aros	
arquitectura	
arreglar	



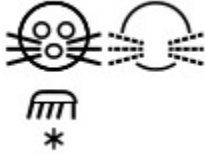

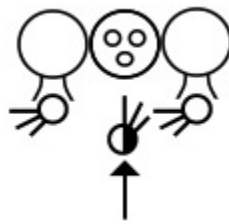
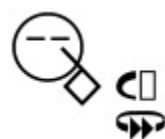

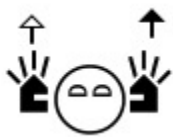

# Lengua de señas argentina; LSA

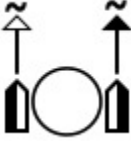
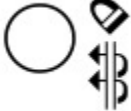
Spoken Word	SignWriting
arrepentimiento	<p>The signwriting consists of a circle with a horizontal line below it, followed by two hands with fingers spread, and a smiling face with eyes.</p>
arrepentir-1S	<p>The signwriting consists of a horizontal line, two hands with fingers spread, a circle with an 'X' inside, two overlapping circles with arrows pointing towards each other, and a smiling face with eyes.</p>
Arroyito	<p>The signwriting consists of two hands with fingers spread, a circle with an 'X' inside, and a smiling face with eyes.</p>
Arroyito	<p>The signwriting consists of a circle with an 'X' inside, a diamond shape, and two asterisks (**).</p>
arroz	<p>The signwriting consists of a diamond shape, a circle with an 'X' inside, two downward-pointing arrows, and two small circles.</p>
arroz	<p>The signwriting consists of a circle with an 'X' inside, a diamond shape, and two asterisks (**).</p>
Asia	<p>The signwriting consists of a circle with a horizontal line inside, a diamond shape, an asterisk (*), and a right-pointing arrow.</p>
asistencia	<p>The signwriting consists of a diamond shape, a circle with an 'X' inside, a diamond shape, a right-pointing arrow, a diamond shape, a left-pointing arrow, and a diamond shape.</p>







# Lengua de señas argentina; LSA

Spoken Word	SignWriting
asma	
asombro	
asombroso-EXCL	
astucia	
ataque	
atardecer	
Atenas	
atención	



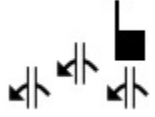
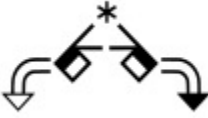

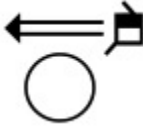

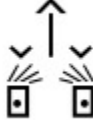

# Lengua de señas argentina; LSA

Spoken Word	SignWriting
atento	
atorrante	
atrapar	
atrapar	
aula	
aula	
ausente	
Australia	
Austria	







# Lengua de señas argentina; LSA

Spoken Word	SignWriting
autismo	
auto	
autonomía	
autopista	
autor	
avisar	
avión	
avión	
ayer	
ayudar	

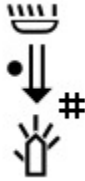
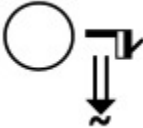
# Lengua de señas argentina; LSA

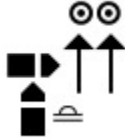
Spoken Word	SignWriting
azul	
azul	
azúcar	
año	
año	
año	
años	
años pasados	
B	

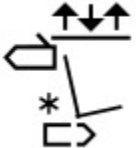
# Lengua de señas argentina; LSA





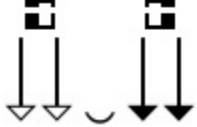



Spoken Word	SignWriting
bajar	
bajo	
balcón	
banco	
bandera	
bandera	
bandera	
barato	

# Lengua de señas argentina; LSA







Spoken Word	SignWriting
barco	
Bariloche	



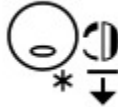

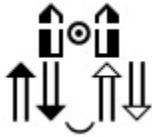

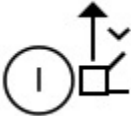

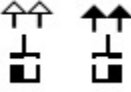

# Lengua de señas argentina; LSA

Spoken Word	SignWriting
barril	
base	
basta-EXCL	
basta-EXCL	
baño	
baño	
baño	
beber	
beber	





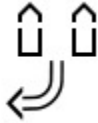

# Lengua de señas argentina; LSA

Spoken Word	SignWriting
beber	
beber	
bebé	
bebé	
beca	
beige	
Belgrano	
Bell Ville	

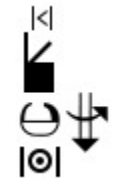
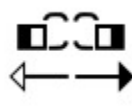
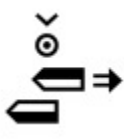







# Lengua de señas argentina; LSA

Spoken Word	SignWriting
belleza	
berenjena	
beso	
beso	
beso	
biblioteca	
bien	
bien-2S	
bienvenido	

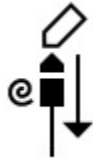





# Lengua de señas argentina; LSA

Spoken Word	SignWriting
bilingüe	
billete	
bisnieto	
blanco	
Boca Juniors	
Bolivia	
Bolivia	
bombero	
bombón	





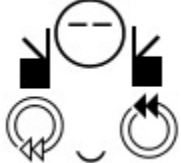
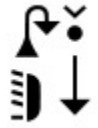
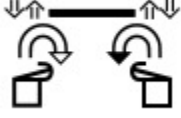

# Lengua de señas argentina; LSA

Spoken Word	SignWriting
bordó	
borrador	
bota	
botella	
Brasil	
bronca	
bronquitis	
bueno	
bueno	
Buenos Aires	



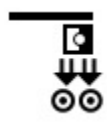
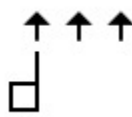

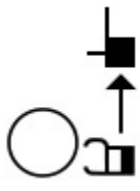

# Lengua de señas argentina; LSA

Spoken Word	SignWriting
bufanda	
burla	
burlar	
burro	
buscar	
buscar	
buzo	
búho	
C	

# Lengua de señas argentina; LSA

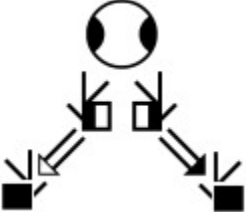

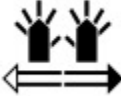

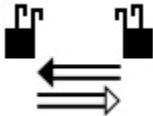
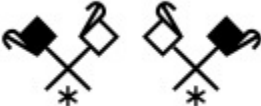





Spoken Word	SignWriting
caballo	
cable	
Cabred	
caca	
cada-uno	
café	
café	
cal	
caliente	
California	

# Lengua de señas argentina; LSA



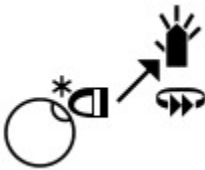



Spoken Word	SignWriting
call-center	
callar	
callar	
calle	
cama	
cambiar	
cambiar-de-tema	
cambiar-tema	
cambio	





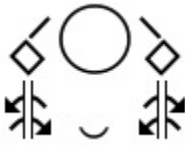

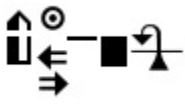
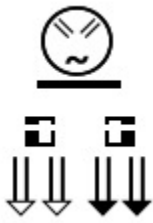

# Lengua de señas argentina; LSA

Spoken Word	SignWriting
camello	
caminar	
caminar	
camioneta	
camisa	
campeón	
campo	
camuflado	
Canadá	
cancha	

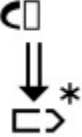

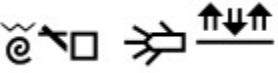



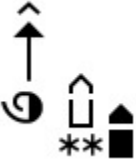
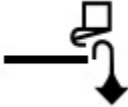

# Lengua de señas argentina; LSA

Spoken Word	SignWriting
cansado	
cantar	
cantar	
cantar	
Capilla del Monte	
capital	
caprichoso	
caramelo	



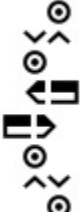



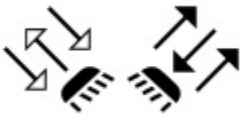

# Lengua de señas argentina; LSA

Spoken Word	SignWriting
Carbó	
cargo	
cariño	
Carlos Paz	
carne	
caro	
Carolina	
carrera	
carta	



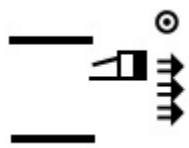
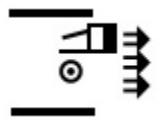



# Lengua de señas argentina; LSA

Spoken Word	SignWriting
carta-documento	
cartera	
carísimo	
casa	
casado	
casamiento	
casero	
casi	
castigo	
Catamarca	

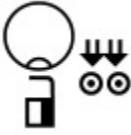
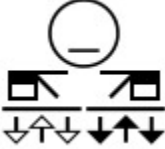
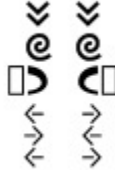

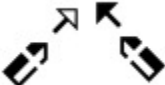

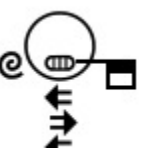



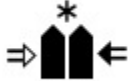

# Lengua de señas argentina; LSA

Spoken Word	SignWriting
categoría	
categoría	
catorce	
católico	
cebra	
cebra	
ceguera	
celeste	
celos	

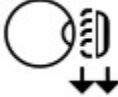

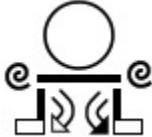
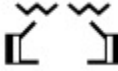

# Lengua de señas argentina; LSA

Spoken Word	SignWriting
celoso	
cenar	
ceniza	
centavo	
centrarse	
Centro	
cepillar dientes	
cerca	
cereal	

# Lengua de señas argentina; LSA

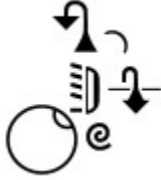

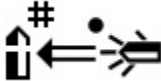
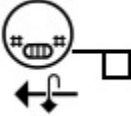

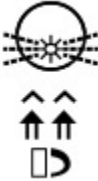
Spoken Word	SignWriting
cerrado	
cerrar	
cerveza	
cesárea	
Chaco	
Chaco	
chaleco	
charlar	
cheque	
cheque	
Chevrolet	

# Lengua de señas argentina; LSA





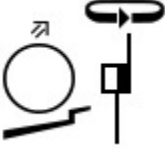
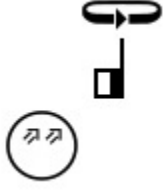
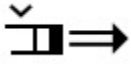

Spoken Word	SignWriting
Chicago	
Chile	
China	
chisme	
chocar	
choclo	
chocolate	
chofer	
chorro de agua	



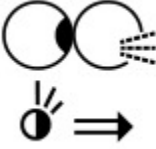



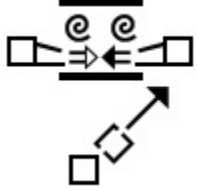
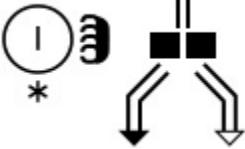

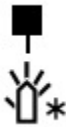

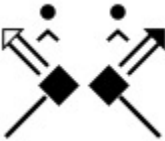

# Lengua de señas argentina; LSA

Spoken Word	SignWriting
Chubut	
chusma	
chusma	
cielo	
cielo	
cien	
ciencia	
científico	





# Lengua de señas argentina; LSA

Spoken Word	SignWriting
cierto	
cinco	
cincuenta	
cine	
cine	
cinturón	
circo	
Citröen	
ciudad	









# Lengua de señas argentina; LSA

Spoken Word	SignWriting
civil	
claro	
clavar	
clima	
CM-0	
CM-a	
CM-b	
CM-c	
CM-capullo	
CM-cinco	
CM-cuatro	
CM-cuerno	

# Lengua de señas argentina; LSA

Spoken Word	SignWriting
CM-cuernos pico	
CM-cuernos óvalo	
CM-d	
CM-d óvalo	
CM-dos	
CM-dos flexionado	
CM-dúo	
CM-dúo-pulgar	
CM-e inglesa	
CM-gancho	
CM-garra abierta	
CM-garra cerrada	
CM-ind-mayor-anular	
CM-k	









# Lengua de señas argentina; LSA

Spoken Word	SignWriting
CM-k cerrada	
CM-l	
CM-l plegada	
CM-l óvalo	
CM-llave	
CM-mano ahuecada	
CM-mayor flexionado	
CM-medio círculo	
CM-meñique	









# Lengua de señas argentina; LSA

Spoken Word	SignWriting
CM-mitón	
CM-p	
CM-palma	
CM-pico	
CM-pulgar	
CM-puño	
CM-r	
CM-tres	
CM-y	
CM-ángulo	
CM-ángulo abierto	
CM-ángulo cerrado	
CM-índice	
CM-óvalo	

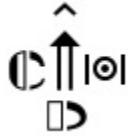
# Lengua de señas argentina; LSA



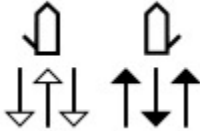
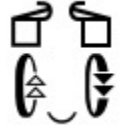





Spoken Word	SignWriting
cobrar	
coca cola	
cocina	
cocinar	
cocodrilo	
codo	
cohete	
coima	
colectivo	

# Lengua de señas argentina; LSA

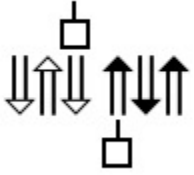



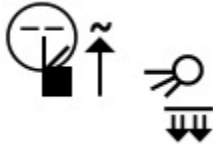

Spoken Word	SignWriting
Colombia	
Colonia Caroya	
color	
comenzar	
comer	
comer	
comodín	
comparación	
compartir	
compartir	





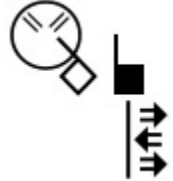



# Lengua de señas argentina; LSA

Spoken Word	SignWriting
compañero	
compensación	
competencia	
completo	
comprar	
computadora	
comunicar	
comunidad	
concreto	
conectar	

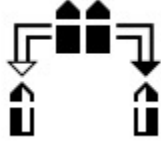



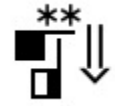

# Lengua de señas argentina; LSA

Spoken Word	SignWriting
confitería	
confusión	
congreso	
conocer-NEG	
conocimiento	
conquistar	
constante	
constante	



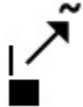
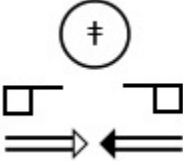

# Lengua de señas argentina; LSA

Spoken Word	SignWriting
constructor	
consultorio	
contabilidad	
contacto	
contacto	
contagiar	
contagiar	
contar	
contar	



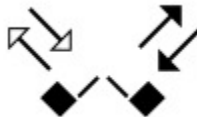
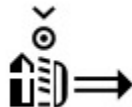

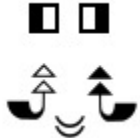
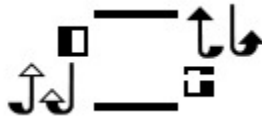

# Lengua de señas argentina; LSA

Spoken Word	SignWriting
contar	
contento	
contexto	
contra	
contradicción	
contrario	
contrato	
conveniencia	

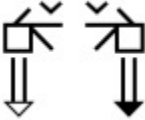

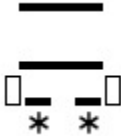
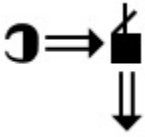

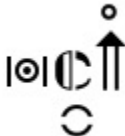



# Lengua de señas argentina; LSA

Spoken Word	SignWriting
conversar	
coordinador	
copiar	
Corea	
correr	
correr	
correr	
Corrientes	
cortafierro	

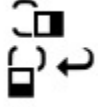

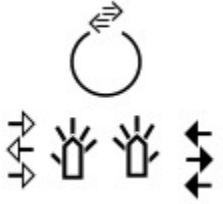

# Lengua de señas argentina; LSA

Spoken Word	SignWriting
cortar	
cortina	
corto	
Costa Rica	
costumbre	
crear	
creencia	
creer	

# Lengua de señas argentina; LSA

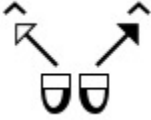

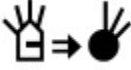

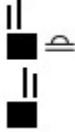

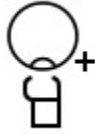

Spoken Word	SignWriting
Crescomas	
criollito	
criollito	
criollo	
cristiano	
cuadrado-CL	
cuadro	
cual	
cualidad	

# Lengua de señas argentina; LSA









Spoken Word	SignWriting
cualquier	
cuarenta	
cuarenta	
cuarto	
cuatro	
cucheta	



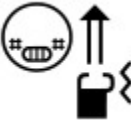
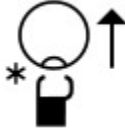





# Lengua de señas argentina; LSA

Spoken Word	SignWriting
cuero	
cuidado	
cuidado-EXCL	
cultura	
cumplir	
cuota	
curar	
curioso	
cuál-INT	
cuántas veces-INT	





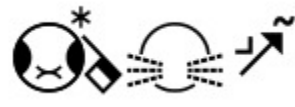
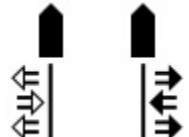

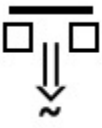

# Lengua de señas argentina; LSA

Spoken Word	SignWriting
cuánto-INT	
cuñado	
cáncer	
código	
cómico	
cómo	
cómodo	
cómodo	
Córdoba	
D	



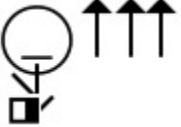



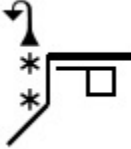

# Lengua de señas argentina; LSA

Spoken Word	SignWriting
D	
dar	
dar-asco	
darse-cuenta	
de-frente-EXCL	
de-golpe	
de-nada-EXCL	
de-nada-EXCL	
deber-SG-1S	







# Lengua de señas argentina; LSA

Spoken Word	SignWriting
decidir	
decir	
decir	
decir	
decir	
decir	
decir	
decir	
decisión	



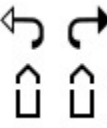
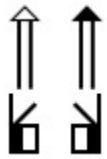



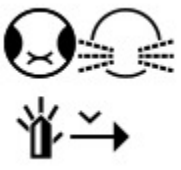

# Lengua de señas argentina; LSA

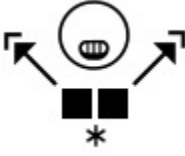
Spoken Word	SignWriting
defensa	
defensa	
dejar	
delante	
deletrear	
delicado	
delincuente	
demasiado	

# Lengua de señas argentina; LSA

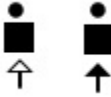
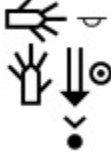
Spoken Word	SignWriting
demorar	
demorar	
demostración	
departamento	
departamento	
depender	
derecho	
derecho	
desaparecer	

# Lengua de señas argentina; LSA









Spoken Word	SignWriting
desastre	
descanzar	
descender	
descripción	
descubrí	
descuento	
desierto	
desordenado	
desove	

# Lengua de señas argentina; LSA





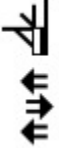





Spoken Word	SignWriting
despedido	<p>The signwriting for 'despedido' consists of a horizontal line at the top, a hand with fingers spread below it, and a downward-pointing arrow to the right of the hand.</p>
despedir	<p>The signwriting for 'despedir' is a hand with fingers spread, positioned above a vertical line that ends in a downward-pointing arrow.</p>
despertar	<p>The signwriting for 'despertar' features a central circle with eyelashes inside, flanked by two hands with fingers spread, each with an upward-pointing arrow above it.</p>
despido	<p>The signwriting for 'despido' includes a hand with fingers spread, a vertical line with an asterisk at the bottom, and a hand with fingers spread to the right, with an upward-pointing arrow above it.</p>
despistado	<p>The signwriting for 'despistado' shows a circle with a horizontal line inside, a hand with fingers spread to the right, and a hand with fingers spread below it, with an upward-pointing arrow above it.</p>
desprestigio	<p>The signwriting for 'desprestigio' consists of a circle with a horizontal line inside, a hand with fingers spread to the right, and a vertical line with an upward-pointing arrow above it.</p>
después	<p>The signwriting for 'después' features a hand with fingers spread, a hand with fingers spread to the right, and a vertical line with an upward-pointing arrow above it.</p>
destacar	<p>The signwriting for 'destacar' is a vertical line with an upward-pointing arrow above it.</p>
detectar	<p>The signwriting for 'detectar' includes a circle with an 'X' inside, a hand with fingers spread, a hand with fingers spread to the right, and a hand with fingers spread above it, with an upward-pointing arrow above it.</p>
deuda	<p>The signwriting for 'deuda' consists of a hand with fingers spread, a vertical line with an upward-pointing arrow above it, and a circle with an '@' symbol inside below the vertical line.</p>





# Lengua de señas argentina; LSA

Spoken Word	SignWriting
devolver	
Deán Funes	
dia	
diagnóstico	
diario	
dibujo	
diccionario	
Diciembre	
dictadura	





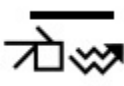
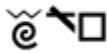
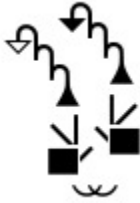

# Lengua de señas argentina; LSA

Spoken Word	SignWriting
diecinueve	
dieciocho	
diecisiete	
dieciséis	
dietético	
diez	
diferencia	
diferente	
diferente	
diferente-EXCL	
difícil	

# Lengua de señas argentina; LSA

Spoken Word	SignWriting
digno	
Dinamarca	
dinero	
dinosaurio	
Dios	
direccional	

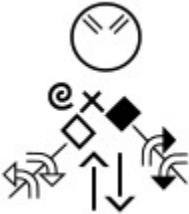







# Lengua de señas argentina; LSA

Spoken Word	SignWriting
directo	
director	
discapacidad	
disco	
discurso	
discutir	
diseñador gráfico	
disfrutar	

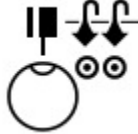
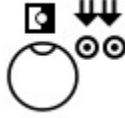





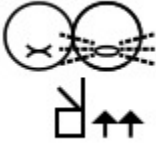

# Lengua de señas argentina; LSA

Spoken Word	SignWriting
disimulo	<p>The signwriting for 'disimulo' consists of a horizontal line at the top, followed by two vertical bars with arrows pointing outwards, and two 'e' characters below them.</p>
distráido	<p>The signwriting for 'distráido' features two hand shapes with arrows pointing outwards, a central circle containing two upward-pointing arrows, and another hand shape with arrows pointing outwards.</p>
diversidad	<p>The signwriting for 'diversidad' shows a hand shape with arrows pointing outwards, a square, and two sets of arrows pointing up and down, with a horizontal arrow below.</p>
divertir	<p>The signwriting for 'divertir' consists of two hand shapes with arrows pointing outwards, and two sets of arrows pointing up and down.</p>
dividir	<p>The signwriting for 'dividir' shows a hand shape with an arrow pointing down and to the right, and another arrow pointing right.</p>
divorcio	<p>The signwriting for 'divorcio' features a circle with a vertical line through it, two horizontal bars with arrows pointing outwards, and two hand shapes with arrows pointing outwards.</p>
divulgar	<p>The signwriting for 'divulgar' includes a hand shape with an arrow pointing up and to the right, a hand shape with an arrow pointing down and to the right, two circles with arrows pointing outwards, and two squares.</p>
DJCAS	<p>The signwriting for 'DJCAS' shows a hand shape with an arrow pointing up and to the right, a hand shape with an arrow pointing left, and two asterisks.</p>
doce	<p>The signwriting for 'doce' consists of a hand shape with an arrow pointing up and to the right, and a circle with an asterisk.</p>







# Lengua de señas argentina; LSA

Spoken Word	SignWriting
doce	
dolor	
dominado	
domingo	
domingo	
donación	
dorado	
dormilón	
dormir	
dos	

# Lengua de señas argentina; LSA

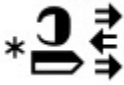

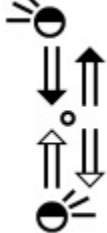



Spoken Word	SignWriting
dos-formas	
dos-semanas	
dos-veces	
duda	
dueño	
dulce	
dulce-de-leche	
duro	
duro	
día	

# Lengua de señas argentina; LSA



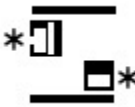
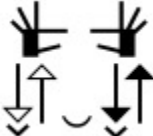

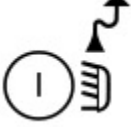



Spoken Word	SignWriting
día-de-la-independencia	
dólar	
dónde-INT	
E	
Ecuador	
editar	
educación	
educación física	
edulcorante	
efectivo	

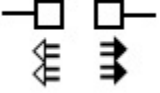







# Lengua de señas argentina; LSA

Spoken Word	SignWriting
Egipto	
egoísta	
ejemplo	
El Salvador	
elección	
elefante	
elefante	
ellos	
ellos	





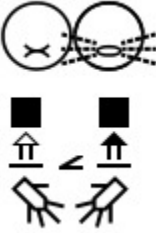
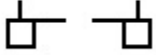

# Lengua de señas argentina; LSA

Spoken Word	SignWriting
ellos	
ellos	
elástico	
Embalse	
embarazo	
emergencia	
empanada	
empresa	
en punto	
en-general	

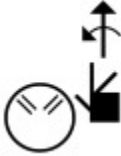



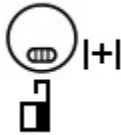

# Lengua de señas argentina; LSA

Spoken Word	SignWriting
enamorar	
enchufe	
encontrar	
encontrar	
encontrar	
encontrar	
enemigo	
Enero	
enfermedad	





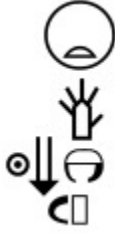

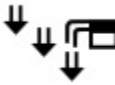
# Lengua de señas argentina; LSA

Spoken Word	SignWriting
enojar	
enseñar	
entender	
entender-NEG	
Entre Ríos	
enviar-a-todos	
envidia	
enólogo	
epidemia	

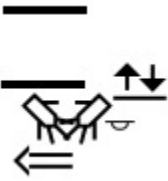
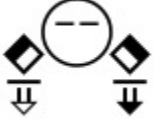





# Lengua de señas argentina; LSA

Spoken Word	SignWriting
equipo	
equivocado	
equivocar	
erizo	
es decir	
escabullir-1S-PAS	
escabullir-DL-PAS	
escalera	



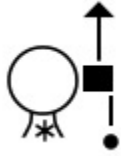

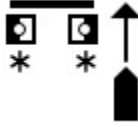
# Lengua de señas argentina; LSA

Spoken Word	SignWriting
Escocia	
esconder	
escribir	
escritura	
escuchar	
escuchar	
escuela	
escupir	

# Lengua de señas argentina; LSA

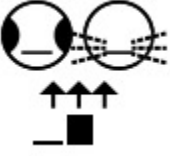
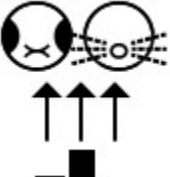

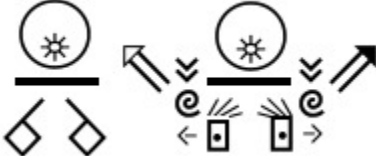
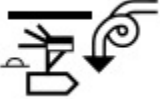

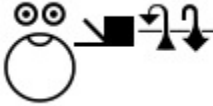
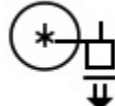



Spoken Word	SignWriting
eso	
eso	
eso	
España	
España	
espejo	
esperanza	
esperar	
esperar	

# Lengua de señas argentina; LSA

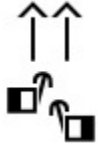





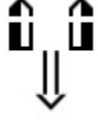

Spoken Word	SignWriting
esperar	
esperar	
espíar	
espíritu	
espíritu	
esqueleto	
esquina	
esquizofrenia	
estación de servicio	

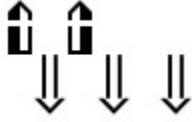









# Lengua de señas argentina; LSA

Spoken Word	SignWriting
Estados Unidos	
estar	
estimulación	
estricto	
estructura	
estructura	
estudiante	
estudio	
etapa	

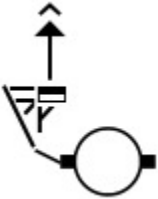





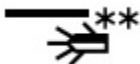

# Lengua de señas argentina; LSA

Spoken Word	SignWriting
etapas	
etc	
etc-CL	
etiqueta	
euro	
evaluación	
exactamente	
experiencia	
explicar	





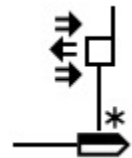

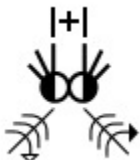

# Lengua de señas argentina; LSA

Spoken Word	SignWriting
expresión	
extenso	
externo	
extracción	
extrañar	
F	
factura	
facultad	
fallar	
falso	



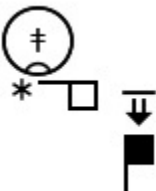



# Lengua de señas argentina; LSA

Spoken Word	SignWriting
faltar	
familia	
famoso	
fanfarrón	
fanta	
fantasía	
faringitis	
farmacia	
Febrero	
federación	



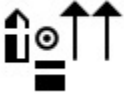
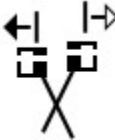
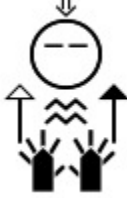





# Lengua de señas argentina; LSA

Spoken Word	SignWriting
felicidad	
felicidades-EXCL	
feliz	
feo	
feo	
feo	
feriado	
fermentación	









# Lengua de señas argentina; LSA

Spoken Word	SignWriting
fernet	
fiambre	
fiambre	
fianlizar	
Fiat	
fichero	
fichero	
FIDE	
fiebre	
fiesta	

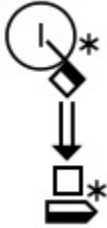
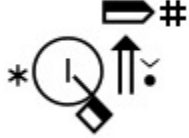
# Lengua de señas argentina; LSA





Spoken Word	SignWriting
fijo	
filosofía	
filtro	
finalizar	
fino	
firma	
fisioterapia	
fisura	
flora	

# Lengua de señas argentina; LSA



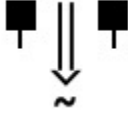

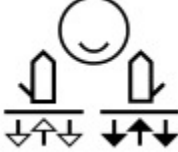

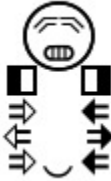
Spoken Word	SignWriting
foca	
fondo	
fondo	
fondo	
fondo	
fonoaudiología	
Ford	
forma	
Formosa	
Formosa	



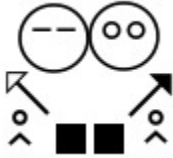

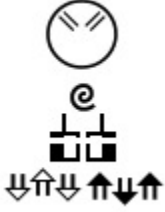
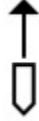



# Lengua de señas argentina; LSA

Spoken Word	SignWriting
fracaso	
Francia	
franco	
fresco	
fretacho	
fruta	
frío	



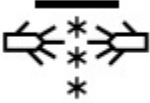
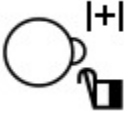

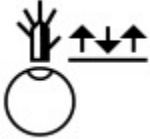



# Lengua de señas argentina; LSA

Spoken Word	SignWriting
fucsia	
fuerte	
funcionar-NEG	
FUT-CL	
futuro	
futuro	
fábrica	
fábrica	







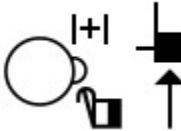

# Lengua de señas argentina; LSA

Spoken Word	SignWriting
fácil	
fármaco	
física	
físico	
G	
Gallaudet	
galleta	
gallo	
ganar	





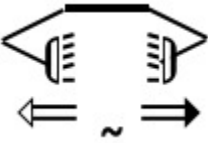

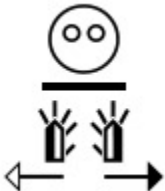
# Lengua de señas argentina; LSA

Spoken Word	SignWriting
ganar-1S-SG-EXCL	
ganar-SG-1S-EXCL	
gastar	
Gastón	
gemelo	
General Paz	
geografía	
Ghana	
gimnasia	
gol	

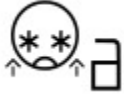
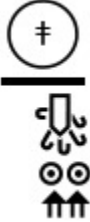





# Lengua de señas argentina; LSA

Spoken Word	SignWriting
gordo	
gordo	
gorra	
gorro	
Grace	
grado	
grande	
grande	
grande	





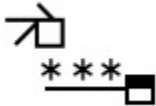
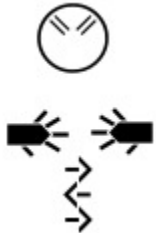
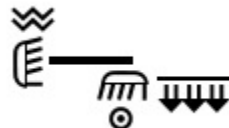



# Lengua de señas argentina; LSA

Spoken Word	SignWriting
grano	
grasa	
gratuito	
grave	
Grecia	
Grecia	
gripe	
gris	

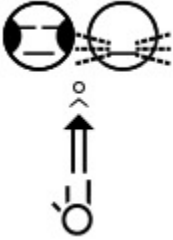
# Lengua de señas argentina; LSA

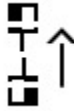

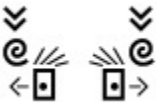

Spoken Word	SignWriting
grosero	
guante	
guardar	
guardia	
Guatemala	
guerra	
guitarra	
gusano	
gusta	

# Lengua de señas argentina; LSA





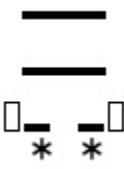
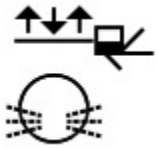
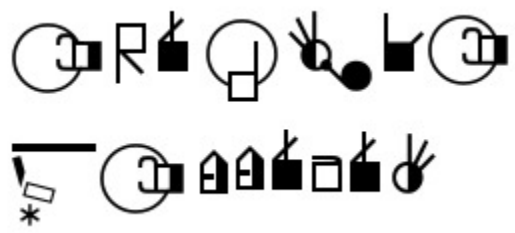

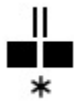

Spoken Word	SignWriting
gustar	
gustar-NEG	
gustar-NEG-EXCL	
gusto	
guía	
H	
habilidad	
habla	
hace-mucho	







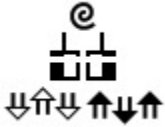
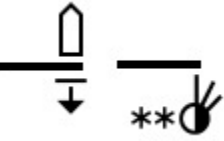

# Lengua de señas argentina; LSA

Spoken Word	SignWriting
hace-poco	
hacer-2S-EXCL	
hasta	
hasta-la-rodilla	
helicóptero	
henrique-febbraro	
hepatitis	
herencia	
hermano	



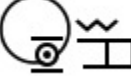

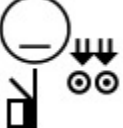
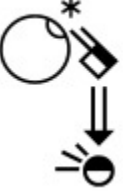

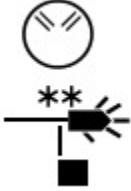

# Lengua de señas argentina; LSA

Spoken Word	SignWriting
hermoso	
herpes	
hijo	
hilo	
himno	
hipopótamo	
historia	
historia	
historia	

# Lengua de señas argentina; LSA

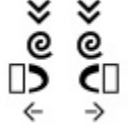
Spoken Word	SignWriting
hola	
hola	
Holanda	
hombre	
hombre	
homónimo	
Honduras	
honesto	
honorarios	





# Lengua de señas argentina; LSA

Spoken Word	SignWriting
hora	
hora-INT	
hospital	
hotel	
huevo	
húmedo	
I	
IBIS	
idea	

# Lengua de señas argentina; LSA

Spoken Word	SignWriting
idea	The SignWriting symbol for 'idea' consists of a large circle on the left containing two smaller circles. To the right of this circle is a vertical line with a horizontal bar at the top, and an arrow pointing upwards from the bottom of the vertical line. Above the vertical line are two small circles, each with a wavy line above it, representing a thought or idea.
identidad	The SignWriting symbol for 'identidad' features a thick horizontal bar at the top. Below this bar are two small asterisks, followed by a square with a vertical line through its center, and finally a horizontal line at the bottom.

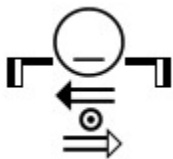
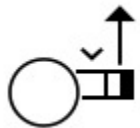
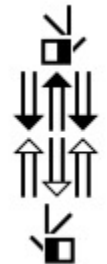





# Lengua de señas argentina; LSA

Spoken Word	SignWriting
identidad	
identificación	
ideología	
idioma	
ignorante	
igual	
importación	
importante-EXCL	

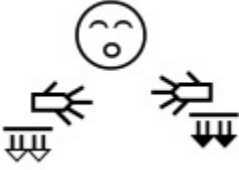
# Lengua de señas argentina; LSA



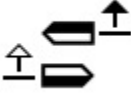
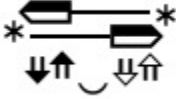
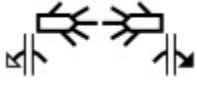

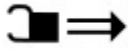

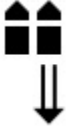

Spoken Word	SignWriting
importar	<p>The signwriting for 'importar' consists of a circle containing a horizontal line with a dot above it, positioned above a vertical line that ends in a small square. To the right of the vertical line is a horizontal line with two arrows pointing outwards.</p>
importar-1S-NEG-EXCL	<p>The signwriting for 'importar-1S-NEG-EXCL' features a circle with two horizontal lines inside, positioned above a solid black square. Below the square is a vertical line with a downward-pointing arrow, which terminates in a horizontal line with a downward-pointing arrow.</p>
importar-SG-NEG-EXCL	<p>The signwriting for 'importar-SG-NEG-EXCL' shows a circle with two horizontal lines inside, positioned above a vertical line with an upward-pointing arrow. This arrow points to a solid black square.</p>
impresionado	<p>The signwriting for 'impresionado' includes a circle with a horizontal line and a dot above it, positioned above a vertical line with a downward-pointing arrow. Below this is a hand icon with a '#' symbol next to it.</p>
impuesto	<p>The signwriting for 'impuesto' consists of a horizontal line on the left, followed by a vertical line that ends in a small square. To the right of the vertical line is a hand icon with a downward-pointing arrow.</p>
impulsivo	<p>The signwriting for 'impulsivo' features a circle with a horizontal line and a dot above it, positioned above a hand icon. The hand icon has an upward-pointing arrow above it and another upward-pointing arrow to its right.</p>
inclusión	<p>The signwriting for 'inclusión' includes a circle with a horizontal line and a dot above it, positioned above a vertical line with a downward-pointing arrow. Below this is a hand icon with a vertical line and a dot above it.</p>

# Lengua de señas argentina; LSA



Spoken Word	SignWriting
increíble	
increíble-EXCL	
incubación	
incurable	
incómodo	
indemnización	
independencia	
independiente	
India	
Indonesia	







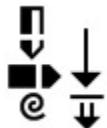
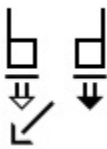
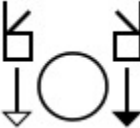
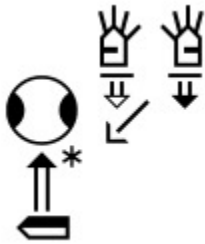
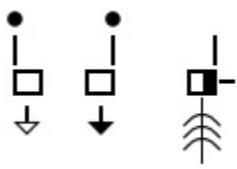

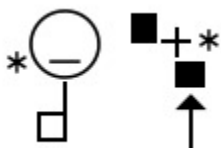

# Lengua de señas argentina; LSA

Spoken Word	SignWriting
inferior	
inflamación	
inflexible	
influencia	
influenciar	
ingeniería	
Inglaterra	
ingresar	

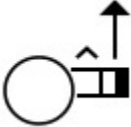
# Lengua de señas argentina; LSA

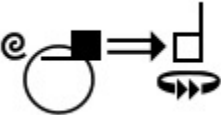
Spoken Word	SignWriting
ingresar	
inmigración	
inmigración	
inmigración-SUPERL	
innecesario	
inocente	
inspector	
insultar	









# Lengua de señas argentina; LSA

Spoken Word	SignWriting
INT-CL	
inteligente	
inteligente	
intensidad	
interesar	
internacional	
internet	
internet	
interrumpido	
intoxicación	

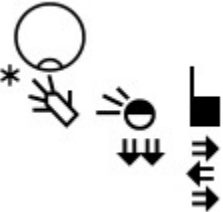



# Lengua de señas argentina; LSA

Spoken Word	SignWriting
intérprete	<p>The signwriting consists of two mirrored hand configurations. Each hand has a diamond-shaped palm facing left and right. The left hand has an upward arrow above the palm and a downward arrow below it. The right hand has a downward arrow below the palm and an upward arrow above it.</p>
inventar	<p>The signwriting consists of two hand configurations. The left hand has a circle with a star above it and a diamond-shaped palm facing left. The right hand has a vertical line with an upward arrow above it, a diamond-shaped palm facing right, and a circle with a vertical line through it to the right.</p>
inventar	<p>The signwriting consists of two hand configurations. The left hand has a circle with a star above it and a diamond-shaped palm facing left. The right hand has a vertical line with an upward arrow above it and a diamond-shaped palm facing right.</p>
investigación	<p>The signwriting consists of three hand configurations. The first hand has a circle with a horizontal line through it and a diamond-shaped palm facing left. The second and third hands are identical, each with a vertical line with a wavy top and a diamond-shaped palm facing right.</p>
invitación	<p>The signwriting consists of two hand configurations. The left hand has a diamond-shaped palm facing left and a hook-like shape above it. The right hand has a diamond-shaped palm facing right and a hook-like shape above it.</p>
invitar	<p>The signwriting consists of two hand configurations. The left hand has a diamond-shaped palm facing left and a hook-like shape above it. The right hand has a diamond-shaped palm facing right and a hook-like shape above it, with a star above the hook.</p>
inyección	<p>The signwriting consists of two hand configurations. The left hand has a diamond-shaped palm facing left and a hook-like shape above it. The right hand has a circle with a diamond-shaped palm facing right and a downward arrow above it.</p>
ir	<p>The signwriting consists of two hand configurations. The left hand has a diamond-shaped palm facing left and a hook-like shape above it. The right hand has a diamond-shaped palm facing right and a hook-like shape above it, with an upward arrow above the hook.</p>
ir	<p>The signwriting consists of two hand configurations. The left hand has a diamond-shaped palm facing left and a hook-like shape above it. The right hand has a diamond-shaped palm facing right and a hook-like shape above it, with an upward arrow above the hook.</p>





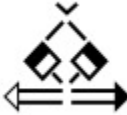
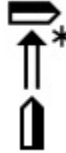
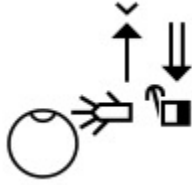
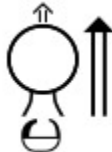

# Lengua de señas argentina; LSA

Spoken Word	SignWriting
ir	
Irlanda	
irreal	
irresponsable	
Islas Malvinas	
Islas Malvinas	
Islas Malvinas	
Israel	
Italia	



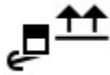

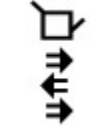





# Lengua de señas argentina; LSA

Spoken Word	SignWriting
J	
jabón	
jabón	
Jamaica	
Japón	
jefe	
Jerónimo Luis de Cabrera	
jirafa	

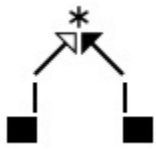
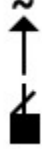
# Lengua de señas argentina; LSA



Spoken Word	SignWriting
jirafa	
jirafa	
Jorgelina	
jubilación	
judío	
judío	
jueves	
jugar	
jugo	

# Lengua de señas argentina; LSA







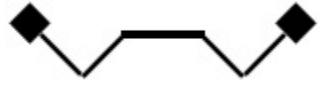

Spoken Word	SignWriting
Julio	
julio	
Junio	
juntar	
juntar	
justificación	
jóven	
K	
Kenia	
kilómetro	
kiosco	





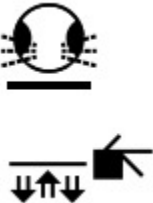



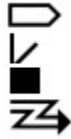

# Lengua de señas argentina; LSA

Spoken Word	SignWriting
L	
La Calera	
La Cumbre	

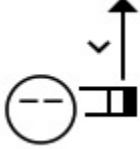





# Lengua de señas argentina; LSA

Spoken Word	SignWriting
La Falda	
La Pampa	
La Rioja	
La Rioja	
lavandería	
lavar	
lavar	
lavarse	
leer	

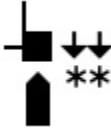

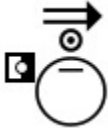
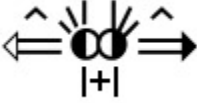
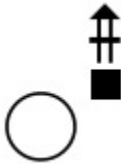



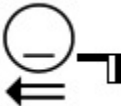

# Lengua de señas argentina; LSA

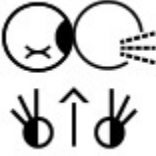
Spoken Word	SignWriting
leer	
leer	
lejos	
lengua-de-señas	
lento	
lento	
levantar	
leve	







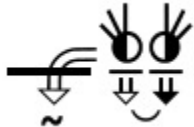

# Lengua de señas argentina; LSA

Spoken Word	SignWriting
ley	
ley	
león	
liberal	
libertad	
libro	
limpiar	
limón	
lindo	
lingüística	

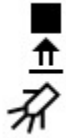







# Lengua de señas argentina; LSA

Spoken Word	SignWriting
listo-EXCL	
liviano	
LL	
llama	
llama	
llamar	
llamar	
llamar-1S-SG	
llamar-SG-1S	
llegar	



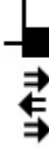

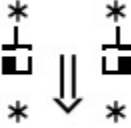

# Lengua de señas argentina; LSA

Spoken Word	SignWriting
lleno	
llevar	
llevar	
llorar	
lluvia	
loco	
loro	
Los Cocos	
Los Reartes	
lucha	

# Lengua de señas argentina; LSA

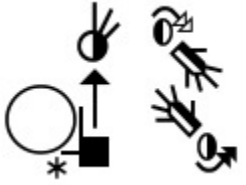

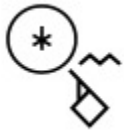
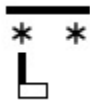

Spoken Word	SignWriting
lugar	
Luis Juez	
lujo	
luna	
lunes	
Luque	
luz	
lámina	
lástima	

# Lengua de señas argentina; LSA



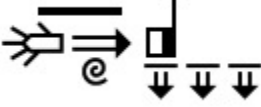
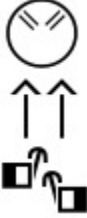
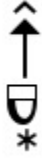

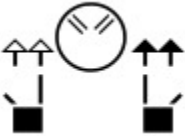
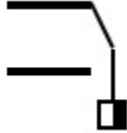

Spoken Word	SignWriting
lástima	
límite	
lío	
M	
mac	
madera	
madrstra	
madre	
madrugada	



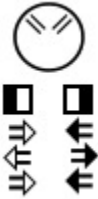
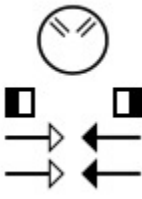

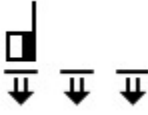





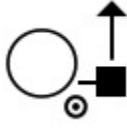

# Lengua de señas argentina; LSA

Spoken Word	SignWriting
maestro	
maestro	
mafioso	
mal	
mal	
maldición	
maletín	
malhumorado	









# Lengua de señas argentina; LSA

Spoken Word	SignWriting
malo	
malo	
malo	
mandar	
mandar	
manipulación	
mantención	
manzana	

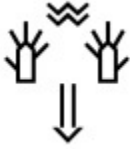
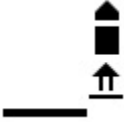



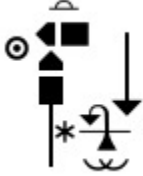

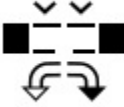

# Lengua de señas argentina; LSA

Spoken Word	SignWriting
Mar del Plata	
maratón	
marca	
Marcos Juárez	
mareo	
Mariana	
Marruecos	
marrón	
martes	
martillo-neumático	

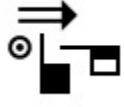
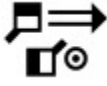







# Lengua de señas argentina; LSA

Spoken Word	SignWriting
Marzo	
mate	
matemática	
mayor	
mañana	
mañana	
mecánico	
media	
media	







# Lengua de señas argentina; LSA

Spoken Word	SignWriting
media	
medialuna	
medicina	
medio	
mediodía	
mejor	
mejorar	
mellizo	
Mendiolaza	
Mendoza	



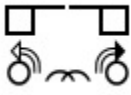

# Lengua de señas argentina; LSA

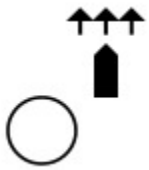
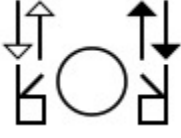
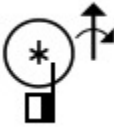
Spoken Word	SignWriting
menor	
menos	
menos	
menos-mal-EXCL	
mensual	
mentira	
merienda	
mes	
mesa	
mestizo	

# Lengua de señas argentina; LSA

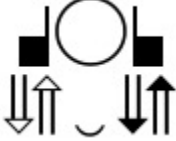

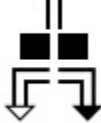
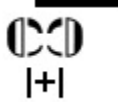

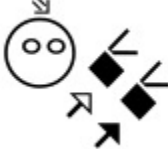

Spoken Word	SignWriting
metal	
metodología-de-la-educación	
metro	
metro	
micro	
miedo	
miel	
mientras-estar-allá	
migración	
mil	

# Lengua de señas argentina; LSA



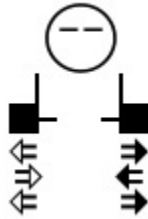

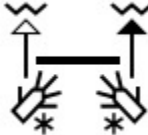
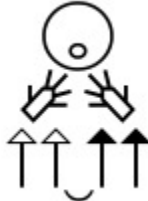
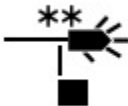



Spoken Word	SignWriting
militar	
Milán	
mimoso	
Mina Clavero	
ministerio	
minoría	
minoría	
minuto	
mira	
Miramar	





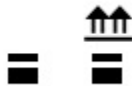





# Lengua de señas argentina; LSA

Spoken Word	SignWriting
mirar	
mirar-CL	
mirar-TV	
Misiones	
miércoles	
mojado	
molestar	
momento	
momento	



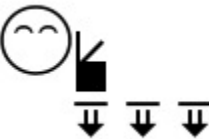

# Lengua de señas argentina; LSA

Spoken Word	SignWriting
Mongolia	
moral	
morocho	
mosquito	
mostrar-2S-1S-EXCL	
moto	
muchas veces	
mudar	
mudo	
mueble	



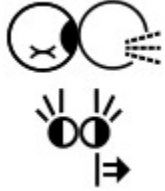

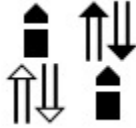
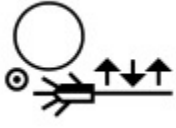

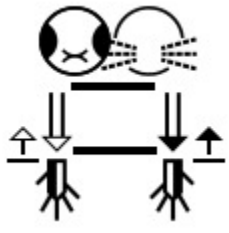

# Lengua de señas argentina; LSA

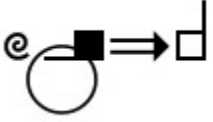
Spoken Word	SignWriting
muerte	
mujer	
multa	
mundo	
municipalidad	
murciélago	
musculosa	
museo	
muy	



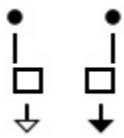





# Lengua de señas argentina; LSA

Spoken Word	SignWriting
muy cerca	
muy-bien	
más	
más-o-menos	
Méjico	
música	
N	
nacimiento	

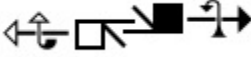

# Lengua de señas argentina; LSA

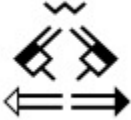
Spoken Word	SignWriting
nacional	
nada	
nada-más	
nafta	
necesitar	
negocio	
negro	
negro	
negro	

# Lengua de señas argentina; LSA

Spoken Word	SignWriting
nena	
Nepal	
nervio	
Neuquén	
NI01	
NI02	
Nicaragua	
nieto	
nieto	

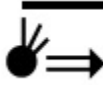
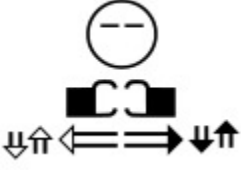
# Lengua de señas argentina; LSA

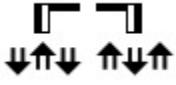
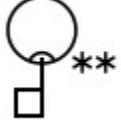
Spoken Word	SignWriting
nieve	
ninguno	
nivel	
nivel	
nivel	
niño	

# Lengua de señas argentina; LSA

Spoken Word	SignWriting
no	<p>The signwriting for 'no' consists of a circle with two parallel diagonal lines inside, positioned above a horizontal line. Below this line is a solid black square, and further down are three horizontal arrows pointing to the right.</p>
no-EXCL	<p>The signwriting for 'no-EXCL' features a circle with a horizontal line and a vertical line intersecting inside, above a horizontal line. Below this line is a hand symbol with a black dot on the palm, and further down are three horizontal arrows pointing to the right.</p>
no-EXCL	<p>The signwriting for 'no-EXCL' shows a hand symbol with a black dot on the palm, positioned above a horizontal line. Below this line is a square with a diagonal line, and further down are three horizontal arrows pointing to the right.</p>
no-FEM	<p>The signwriting for 'no-FEM' includes a circle with a horizontal line and a vertical line intersecting inside, above a horizontal line. Below this line is a hand symbol with a black dot on the palm, and further down are three horizontal arrows pointing to the right.</p>
no-hay	<p>The signwriting for 'no-hay' consists of a horizontal line above a square, which is positioned above a vertical line with three horizontal lines extending from its base.</p>
no-hay-más	<p>The signwriting for 'no-hay-más' features a hand symbol with a black dot on the palm, positioned above a horizontal line. Below this line is a square with a diagonal line, and further down are three horizontal arrows pointing to the right.</p>
no-MASC	<p>The signwriting for 'no-MASC' includes a circle with a horizontal line and a vertical line intersecting inside, above a horizontal line. Below this line is a hand symbol with a black dot on the palm, and further down are three horizontal arrows pointing to the right.</p>











# Lengua de señas argentina; LSA

Spoken Word	SignWriting
noche	<p>The sign for 'noche' consists of a circle with a horizontal line through its center, an arrow pointing left above the circle, and a vertical bar with a checkmark on top to its right.</p>
Nono	<p>The sign for 'Nono' features a horizontal bar above a hand shape with fingers spread, and two asterisks below the hand.</p>
normal	<p>The sign for 'normal' is a circle with a hand shape to its right, where the index finger points down and the thumb points right.</p>
normal	<p>The sign for 'normal' is a complex arrangement of symbols: a hand with index finger up, a hand with index finger left, a hand with index finger right, a hand with index finger up, and a hand with index finger left.</p>
Noruega	<p>The sign for 'Noruega' consists of a vertical bar with a checkmark on top, and a stylized 'N' with a checkmark on top to its right.</p>
nosotros	<p>The sign for 'nosotros' is a hand shape with a vertical bar above it and a hand shape below it with index finger pointing right.</p>
nosotros dos	<p>The sign for 'nosotros dos' consists of two vertical arrows pointing up and down, and a hand shape below them with index finger pointing right.</p>
nota	<p>The sign for 'nota' is two hand shapes, each with a vertical bar above it and a hand shape below it with index finger pointing down.</p>
noticia	<p>The sign for 'noticia' is a complex arrangement of symbols: a hand with index finger up, a hand with index finger left, a hand with index finger right, a hand with index finger up, a hand with index finger left, and a hand with index finger right.</p>
noticia	<p>The sign for 'noticia' is two hand shapes, each with a vertical bar above it and a hand shape below it with index finger pointing up.</p>







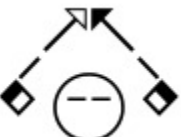

# Lengua de señas argentina; LSA

Spoken Word	SignWriting
noticia	<p>The signwriting for 'noticia' consists of a circle with a horizontal line through its center, positioned above two hand icons. Below the hand icons are two vertical lines, each with a small triangle pointing towards the center.</p>
Noviembre	<p>The signwriting for 'Noviembre' features a hand icon at the top, followed by a vertical line with three arrows pointing downwards, and another hand icon at the bottom.</p>
novio	<p>The signwriting for 'novio' shows a hand icon on the left, a vertical line with a circle at the top, and a hand icon on the right with an arrow pointing downwards.</p>
nudo	<p>The signwriting for 'nudo' includes a vertical line with a dot above it, a hand icon, a vertical line with a dot above it, and a hand icon with an arrow pointing upwards.</p>
Nueva Córdoba	
Nueva York	<p>The signwriting for 'Nueva York' features a hand icon at the top, a vertical line with a circle at the top, and a hand icon at the bottom with an arrow pointing downwards.</p>
Nueva Zelandia	<p>The signwriting for 'Nueva Zelandia' shows a hand icon at the top, a vertical line with a circle at the top, a hand icon at the bottom with an arrow pointing downwards, and a star symbol.</p>
nueve	<p>The signwriting for 'nueve' consists of a circle with a horizontal line through its center, positioned above a hand icon with an arrow pointing downwards.</p>

# Lengua de señas argentina; LSA











Spoken Word	SignWriting
nueve	
nuevo	
nuevo	
nunca	
náusea	
nórdico	
número	
número	
O	
objetivo	

# Lengua de señas argentina; LSA







Spoken Word	SignWriting
obligación	
obligación	
ocasional	
ocho	
ocupado	
ocupado	
odioso	
ofender	







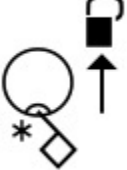
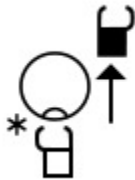



# Lengua de señas argentina; LSA

Spoken Word	SignWriting
oral	
ordenado	
orgullosa	
orientación	
orin	
oscuro	
otro	
ovarios	
oveja	
P	

# Lengua de señas argentina; LSA









Spoken Word	SignWriting
paciencia	
padre	
padrino	
pagar	
paja	
palabra	
palabra	
palmas	

# Lengua de señas argentina; LSA



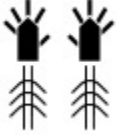

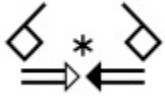

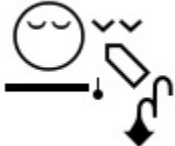

Spoken Word	SignWriting
palpitación	
pan	
pan salvado	
Panamá	
pandemia	
panorama	
pantalón	
papa	
papel	

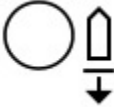

# Lengua de señas argentina; LSA

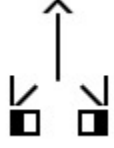
Spoken Word	SignWriting
paperas	
Paquistán	
Paraguay	
parecer	
parecido	
pareja	
particular	
partido	
París	
pasado	







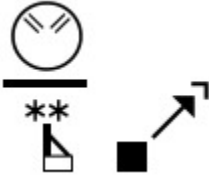

# Lengua de señas argentina; LSA

Spoken Word	SignWriting
pasado	
pasado-mañana	
pasear	
pasear	
pasillo	
pato	
pavada	
payaso	
paz	

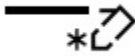

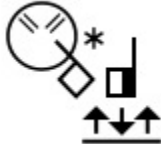
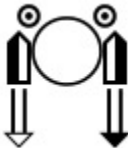

# Lengua de señas argentina; LSA

Spoken Word	SignWriting
país	The signwriting for 'país' consists of three elements: a hand sign with the index finger pointing up and the thumb pointing right, a zigzag line, and a less-than sign (<).
pebete	The signwriting for 'pebete' consists of two hand signs: one with the index finger pointing up and the thumb pointing right, and another with the index finger pointing down and the thumb pointing right, with an asterisk (*) below the second sign.

# Lengua de señas argentina; LSA

Spoken Word	SignWriting
pecado	
pedalear	
pedir	
peinar	
pelado	
pelea	
peligro	
pelo lacio	
peluquería	
penitencia	



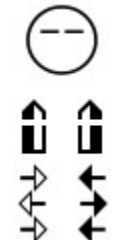
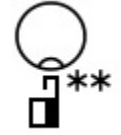
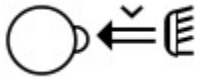





# Lengua de señas argentina; LSA

Spoken Word	SignWriting
pensamiento	
pensamiento	
pensar	
pensar	
pequeño	
pequeño	
pera	
percepción	

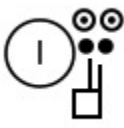

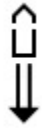
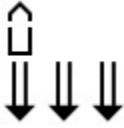

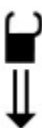

# Lengua de señas argentina; LSA

Spoken Word	SignWriting
percepción	<p>The signwriting consists of a circle with a horizontal line through it on the left, an upward-pointing arrow in the center, and a hand symbol on the right with a downward-pointing arrow and a small dot below it.</p>
perder	<p>The signwriting is a hand symbol with a dollar sign (\$) inside it.</p>
perder	<p>The signwriting consists of two hand symbols, each with a downward-pointing arrow below it.</p>
perfección	<p>The signwriting features a hand symbol with a curved line above it, and another hand symbol below it with a downward-pointing arrow.</p>
perfecto	<p>The signwriting consists of two hand symbols with a star symbol (*) between them, and two horizontal arrows pointing towards each other below.</p>
perfume	<p>The signwriting includes a circle with a horizontal line through it on the left, a hand symbol on the right with a wavy line above it, and two horizontal arrows pointing towards each other below.</p>
perfume	<p>The signwriting consists of a circle with a horizontal line through it on the left and a hand symbol on the right with a downward-pointing arrow below it.</p>
periodismo	<p>The signwriting features a circle with a horizontal line through it on the left, an upward-pointing arrow in the center, and a hand symbol on the right with a downward-pointing arrow below it.</p>
periodista	<p>The signwriting consists of a hand symbol with a diamond shape to its right and two asterisks (**) below.</p>

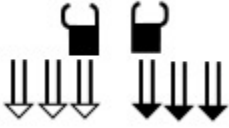
# Lengua de señas argentina; LSA

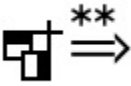



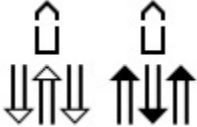



Spoken Word	SignWriting
pero	
perro	
perro	
perseverancia	
persona	
persona	
persona	
persona	
personalidad	

# Lengua de señas argentina; LSA

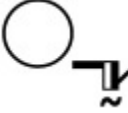

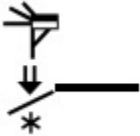

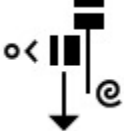

Spoken Word	SignWriting
personas	
pervención	
período	
Perú	
pesadez-de-estómago	
pescado	
peso	
peso	

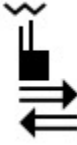

# Lengua de señas argentina; LSA

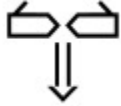
Spoken Word	SignWriting
petición	
petición	
petizo	
pez	
picadura	
picante	
piel	
piel	
piel-de-gallina	

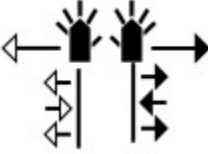
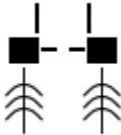





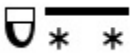

# Lengua de señas argentina; LSA

Spoken Word	SignWriting
pino	
pintar	
pisarla	
planeta	
plano	
plata	
playa	
plaza	
plástico	



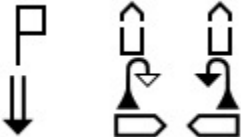

# Lengua de señas argentina; LSA

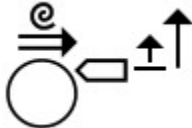
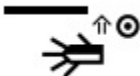
Spoken Word	SignWriting
pobre	
pobre-EXCL	
poco	
poco-a-poco	
poder ser-NEG-EXCL	
poder-NEG	
polera	
policía	
pollera	





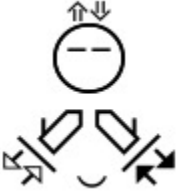

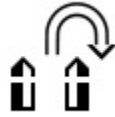
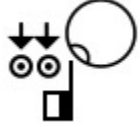
# Lengua de señas argentina; LSA

Spoken Word	SignWriting
Polonia	
político	
pomelo	
poner	
por-eso	
por-favor	
por-favor	
por-favor	
por-fin-EXCL	
por-fin-EXCL	
por-las-dudas	

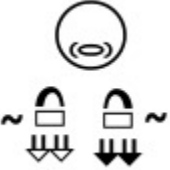
# Lengua de señas argentina; LSA

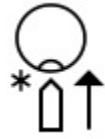
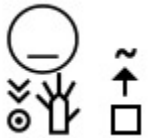
Spoken Word	SignWriting
porcentaje	
Portugal	
portugués	
posibilidad	
posible	
posible-NEG	
posponer	
postre	

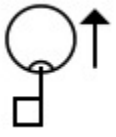





# Lengua de señas argentina; LSA

Spoken Word	SignWriting
pra que	
practicar	
preceptor	
precioso-EXCL	
preferencia	
prefijo	
preguntar	
preguntar	

# Lengua de señas argentina; LSA

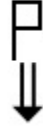

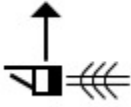



Spoken Word	SignWriting
prejuicio	The SignWriting for 'prejuicio' consists of two main components. On the left, there is a circle with a small asterisk inside, and a hand icon pointing towards it. On the right, there is a vertical arrow pointing upwards, with a solid black square positioned directly below its base.
premio	The SignWriting for 'premio' consists of two main components. On the left, there is a horizontal line above a hand icon. On the right, there are two vertical lines, each topped with a small circle, and a hand icon positioned below them.

# Lengua de señas argentina; LSA

Spoken Word	SignWriting
preocupado	
preparar	
preparar	
presente	
presente	
presión arterial	
prestar	
prevenir	
primario	





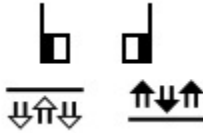





# Lengua de señas argentina; LSA

Spoken Word	SignWriting
primer-piso	
primera-vez	
primera-vez	
primero	
problema	
profesional	
profesor	
professor	









# Lengua de señas argentina; LSA

Spoken Word	SignWriting
profundo	<p>The signwriting for 'profundo' consists of three vertical elements: a downward-pointing arrow, a horizontal arrow pointing right, and a circle with a vertical line through its center.</p>
programa	<p>The signwriting for 'programa' consists of two main parts: a hand with fingers spread pointing up and a hand with fingers spread pointing right, with a horizontal arrow pointing right below the right hand.</p>
progreso	<p>The signwriting for 'progreso' consists of two hands with fingers spread pointing up, with a downward arrow above each hand. Below the hands is a horizontal line with a small circle in the center.</p>
prohibido	<p>The signwriting for 'prohibido' consists of a circle with a diagonal slash through it, and a hand with fingers spread pointing right, with a horizontal line and three downward arrows below it.</p>
prolijo	<p>The signwriting for 'prolijo' consists of two hands with fingers spread pointing up, with a horizontal line and three downward arrows below each hand.</p>
provincia	<p>The signwriting for 'provincia' consists of a hand with fingers spread pointing up, with a horizontal line and three downward arrows below it, and two upward-pointing arrows above it.</p>
proyecto	<p>The signwriting for 'proyecto' consists of two hands with fingers spread pointing up, with a horizontal line and three downward arrows below each hand, and two upward-pointing arrows above each hand.</p>
proyecto	<p>The signwriting for 'proyecto' consists of two hands with fingers spread pointing up, with a horizontal line and three downward arrows below each hand, and two circular arrows below each hand.</p>
psicología	<p>The signwriting for 'psicología' consists of a circle with a horizontal line through it, and a hand with fingers spread pointing right, with a horizontal line and three downward arrows below it.</p>



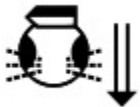
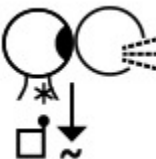
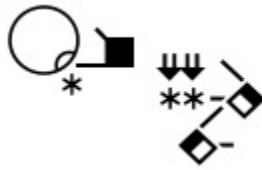

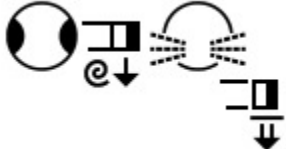

# Lengua de señas argentina; LSA

Spoken Word	SignWriting
psiquiatría	
pueblo	
puente	
puerta	
Puerto Rico	
puma	
puntada	
punto	
puntual	

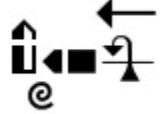

# Lengua de señas argentina; LSA

Spoken Word	SignWriting
página	
página web	
público	
Q	
que-alivio-EXCL	
que-macana-EXCL	
que-tonto-EXCL	
que-vergüenza-EXCL	
que-vergüenza-EXCL	
quemar	





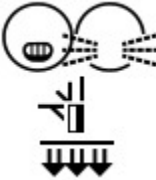
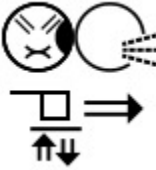
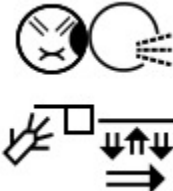
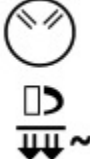

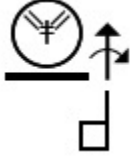

# Lengua de señas argentina; LSA

Spoken Word	SignWriting
querer	
querer	
querer-morir-1S-EXCL	
queso	
quince	
quise	
quitar	
quién-INT	



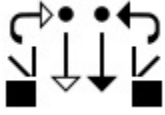

# Lengua de señas argentina; LSA

Spoken Word	SignWriting
qué-feo-EXCL	
qué-fiaca-EXCL	
qué-INT	
qué-INT	
qué-INT	
qué-INT-FUT	
qué-INT-PAS	
R	
rabia	

# Lengua de señas argentina; LSA

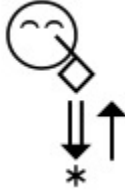

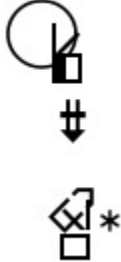
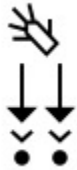
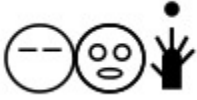
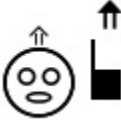



Spoken Word	SignWriting
radio	
raro	
ratón	
reacción	
real	
recaudación	
recibir	
recién	
recomendar	

# Lengua de señas argentina; LSA



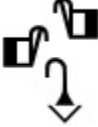

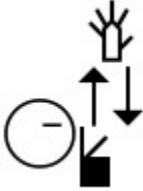
Spoken Word	SignWriting
reconocer	
reconocer	
reconocimiento	
recopilación	
recordar	
recordar	
recreo	
recuerdo	

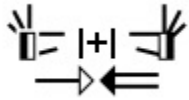

# Lengua de señas argentina; LSA

Spoken Word	SignWriting
recuperar	
recurso	
Reebok	
reemplazar	
reemplazo	
reflejar	
reformador	
registro	
registro civil	
reglamento	

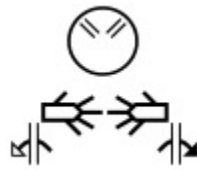

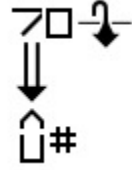



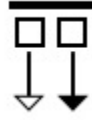

# Lengua de señas argentina; LSA

Spoken Word	SignWriting
reinvindicación	
reir	
relación	
reloj pulsera	
Renault	
renunciar	
reparar	
repentinamente	
repetir	

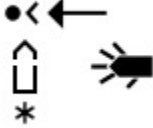
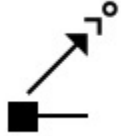







# Lengua de señas argentina; LSA

Spoken Word	SignWriting
reproducción	The SignWriting symbol for 'reproducción' consists of a horizontal line at the top. Below it are two hand shapes, each with a small arrow pointing towards the center. A vertical arrow on the right side points upwards.
República Dominicana	The SignWriting symbol for 'República Dominicana' features a circle on the left containing two asterisks. To the right of the circle is a hand shape with a vertical line extending upwards from the palm.









# Lengua de señas argentina; LSA

Spoken Word	SignWriting
reservado	
reservado	
reservado	
residuo	
respetar	
respeto	
responder	
responder	
responder	

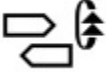
# Lengua de señas argentina; LSA

Spoken Word	SignWriting
responsable	
responsable	
resumen	
reunión	
reverendo	
revisar	
revolución	
ridículo	







# Lengua de señas argentina; LSA

Spoken Word	SignWriting
rifa	
Rivadavia	
rojo	
rollo-CL	
Roma	
rosa	
rosa	
rosario	
rotura	
rubio	

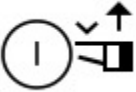
# Lengua de señas argentina; LSA

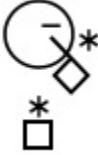

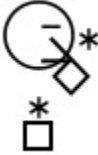





Spoken Word	SignWriting
rubiola	<p>The signwriting for 'rubiola' consists of a circle containing two asterisks (**), representing the color blond, and a small square to its right representing the gender female.</p>
ruido	<p>The signwriting for 'ruido' shows two hands positioned to form a circle. Inside the circle are two hands with fingers spread, representing noise. Below each hand are three arrows pointing outwards, indicating sound waves or movement.</p>
ruleta	<p>The signwriting for 'ruleta' depicts a hand on the left with an arrow pointing left, and a hand on the right with an arrow pointing right, representing the rotation of a roulette wheel.</p>
rulo	<p>The signwriting for 'rulo' shows a central circle with two hands on either side. Each hand has a downward-pointing arrow, and there are small circles above each hand, representing the rolling motion.</p>
rumor	<p>The signwriting for 'rumor' features a curved arrow at the top, a wavy line below it, and two hands at the bottom with fingers spread, representing the spread of a rumor.</p>
rutina	<p>The signwriting for 'rutina' shows a central vertical line with a circle at the top, and two hands below it. Each hand has a circular arrow, representing a routine or cycle.</p>
rápido	<p>The signwriting for 'rápido' depicts two hands on either side of a central vertical line. There are arrows pointing outwards from the hands, and a star-like symbol in the center, representing speed.</p>
rápido	<p>The signwriting for 'rápido' is a complex sequence of symbols: a circle with an asterisk, a diamond, a hand with fingers spread, a circle with a vertical line, and a hand with fingers spread. Below these are several arrows pointing in various directions, representing the concept of speed.</p>

# Lengua de señas argentina; LSA

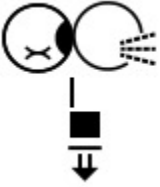

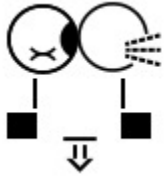



Spoken Word	SignWriting
rápido	
Río Ceballos	
Río Cuarto	
Río Primero	
Río Quinto	
Río Segundo	
Río Tercero	
S	



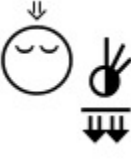





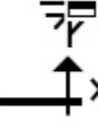

# Lengua de señas argentina; LSA

Spoken Word	SignWriting
Saavedra	
saber	
saber-NEG	
saber-NEG-1S-hacer-2S	
saber-NEG-EXCL	
saber-NEG-PAS	
sabio	
sabor	









# Lengua de señas argentina; LSA

Spoken Word	SignWriting
sabías	
sabías	
sacar	
sacrificio	
sal	
sala	
Salsipuedes	
Salta	
salud-EXCL	

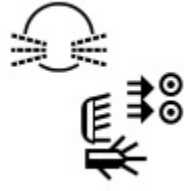
# Lengua de señas argentina; LSA

Spoken Word	SignWriting
salvar	
San Francisco	
San Juan	
San Luis	
San Luis	
San Martín	
sanar	
sandalias	
sandwich	



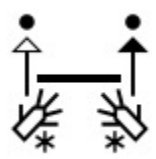





# Lengua de señas argentina; LSA

Spoken Word	SignWriting
sandwich-de-miga	
sangre	
sangre-PL	
Santa Cruz	
Santa Fé	
Santa Rosa	
Santiago del Estero	
sarampión	
Sarmiento	
seco	

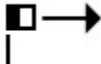
# Lengua de señas argentina; LSA

Spoken Word	SignWriting
secretaría	<p>The signwriting for 'secretaría' consists of a circle at the top, two vertical lines with downward arrows on either side, and a downward arrow with a dot below it.</p>
secreto	<p>The signwriting for 'secreto' features a circle with a horizontal line through it, a downward arrow, and a dot below the arrow.</p>
sed	<p>The signwriting for 'sed' includes a circle with a horizontal line, a small circle to the left, a square below the circle, and a downward arrow.</p>
segundo	<p>The signwriting for 'segundo' shows a circle with a horizontal line, a square to the right, and three downward arrows.</p>
segundo	<p>The signwriting for 'segundo' consists of a square with a diagonal line and a dollar sign below it.</p>
seguro	<p>The signwriting for 'seguro' features a square, a circle with a horizontal line, and a vertical line with a plus sign below it.</p>
según	<p>The signwriting for 'según' shows two vertical lines with upward arrows, a horizontal line connecting them, and another upward arrow on the right.</p>
seis	<p>The signwriting for 'seis' includes a wavy line and a square with a downward arrow.</p>
selección	<p>The signwriting for 'selección' consists of two vertical lines with upward arrows, a downward arrow, a horizontal line, and another downward arrow.</p>

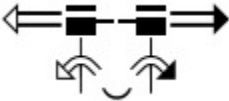







# Lengua de señas argentina; LSA

Spoken Word	SignWriting
selva	
semana	
semana	
senador	
senador	
sensibilidad	
sentarse	
sentimiento	
sentir-NEG	
separación	
separar	

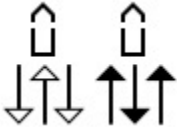
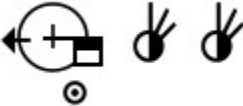
# Lengua de señas argentina; LSA







Spoken Word	SignWriting
Septiembre	

# Lengua de señas argentina; LSA



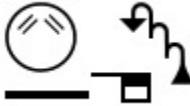

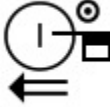
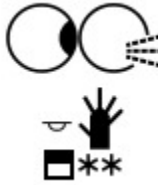



Spoken Word	SignWriting
serio	
serrucho	
servicio	
setecientos	
seña-internacional	
SeñaEscritura	
SeñaEscritura	
señora	
shoping	









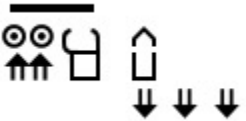



# Lengua de señas argentina; LSA

Spoken Word	SignWriting
si	
si-o-si	
siempre	
siempre	
sierras	
siesta	
siete	
siglo	
significado	
siguiente	



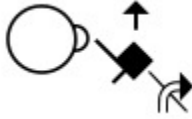



# Lengua de señas argentina; LSA

Spoken Word	SignWriting
silencio	
silla	
simpático	
sinvergüenza	
sistema	
sobre	
sobrepotección	
sobrino	
social	
sociedad	

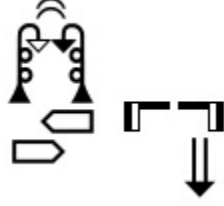





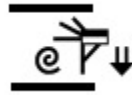



# Lengua de señas argentina; LSA

Spoken Word	SignWriting
soda	
soda	
solamente	
soltero	
sombrero	
sonido	
sordo	
sordomudo	
sorpresa-EXCL	
soñar	

# Lengua de señas argentina; LSA

Spoken Word	SignWriting
su	
subdesarrollo	
subir	
sucio	
sudor	
Suecia	
suegro	
sueldo	









# Lengua de señas argentina; LSA

Spoken Word	SignWriting
sueño	
sueño	
sueño	
sufijo	
Suiza	
suma	
superar	
superficie	
superficie	
supermercado	

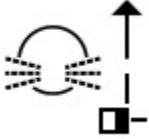

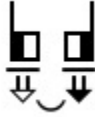



# Lengua de señas argentina; LSA

Spoken Word	SignWriting
suspender	<p>The signwriting consists of two identical symbols side-by-side. Each symbol features a hand with fingers spread, palm facing up, positioned above a horizontal line. An arrow points upwards from the center of the hand.</p>
suspensión	<p>The signwriting is a vertical sequence of symbols. From top to bottom: a hand with fingers spread, palm facing up, with an arrow pointing up; a hand with fingers spread, palm facing up, with an arrow pointing right; a hand with fingers spread, palm facing up, with an arrow pointing up; and finally, a hand with fingers spread, palm facing up, with an arrow pointing right.</p>
Suzuki	
sábado	<p>The signwriting is a vertical sequence of symbols. From top to bottom: a hand with fingers spread, palm facing up, with an arrow pointing right; a hand with fingers spread, palm facing up, with an arrow pointing up; and a hand with fingers spread, palm facing up, with an arrow pointing right.</p>
sí	<p>The signwriting is a vertical sequence of symbols. From top to bottom: a hand with fingers spread, palm facing up, with an arrow pointing right; a hand with fingers spread, palm facing up, with an arrow pointing right; and a hand with fingers spread, palm facing up, with an arrow pointing right.</p>
sí	<p>The signwriting is a vertical sequence of symbols. From top to bottom: a hand with fingers spread, palm facing up, with an arrow pointing right; a hand with fingers spread, palm facing up, with an arrow pointing right; a hand with fingers spread, palm facing up, with an arrow pointing right; and a hand with fingers spread, palm facing up, with an arrow pointing right.</p>
síntoma	<p>The signwriting is a vertical sequence of symbols. From top to bottom: a hand with fingers spread, palm facing up, with an arrow pointing right; a hand with fingers spread, palm facing up, with an arrow pointing right; and a hand with fingers spread, palm facing up, with an arrow pointing right.</p>
T	<p>The signwriting consists of a hand with fingers spread, palm facing up, with an arrow pointing right, positioned above a horizontal line. An asterisk is placed to the right of the line.</p>
tacaño	<p>The signwriting consists of a hand with fingers spread, palm facing up, with an arrow pointing right, positioned above a horizontal line. An asterisk is placed to the right of the line.</p>

# Lengua de señas argentina; LSA

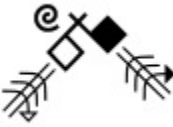
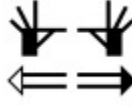

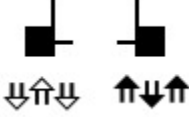
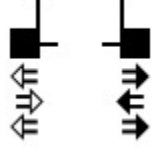

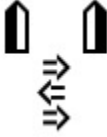

Spoken Word	SignWriting
tacho-de-basura	
Tailandia	
taladro	
tamal	
también	
tampoco	
Tanti	
tardanza	
tarde	
tarea	

# Lengua de señas argentina; LSA

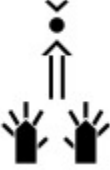

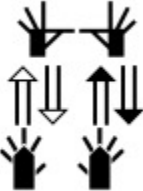

Spoken Word	SignWriting
taxi	
teja	
tejido	
tela	
telegrama	
televisión	
televisor	
tema	
temporada	





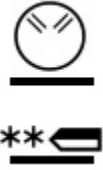

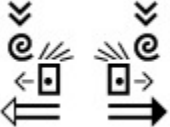

# Lengua de señas argentina; LSA

Spoken Word	SignWriting
temporada	
temprano	
temprano	
tender	
tendiditis	
tendón	
tener	



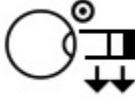

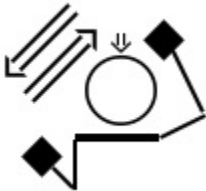



# Lengua de señas argentina; LSA

Spoken Word	SignWriting
tener-hambre	
teología	
teoría	
tercero	
terminar	
testigo	
testimonio	
teólogo	

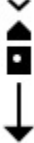



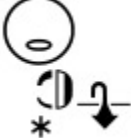

# Lengua de señas argentina; LSA

Spoken Word	SignWriting
tiburón	
tierra	
timidez	
tipear	
toalla	
toallón	
toda-la-tarde	
todas-las-mañanas	
todas-las-personas	



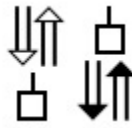
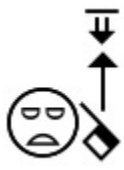
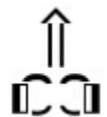



# Lengua de señas argentina; LSA

Spoken Word	SignWriting
todavía	
todo	
todo	
todo	
todo-el-día	
todos	
todos-los-días	
todos-los-martes	
tomar	
tomar	





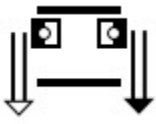

# Lengua de señas argentina; LSA

Spoken Word	SignWriting
tomar	
tomar	
tonto	
torneo	
torpe	
torta	
torta	
tortuga	
tostar	
total	



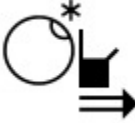
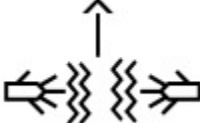





# Lengua de señas argentina; LSA

Spoken Word	SignWriting
trabajo	
tradición	
traducir	
traer	
traición	
traje	
trampa	
tramposo	

# Lengua de señas argentina; LSA











Spoken Word	SignWriting
tranquilidad	
transfusión-1S-SG	
transfusión-SG-1S	
transmitir	
tratamiento	
travieso	
trayectoria	
trece	
treinta	
treinta	

# Lengua de señas argentina; LSA









Spoken Word	SignWriting
tren	
tres	
tribunales	
trigo	
triste	
triste	
trolley	
trámite	
trámites	



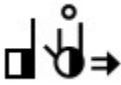

# Lengua de señas argentina; LSA

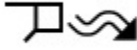
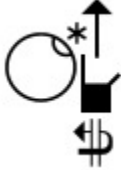
Spoken Word	SignWriting
tuberculosis	
Tucumán	
tufo	
Turquía	
té	
tío	
típico	
título	
tú	
U	

# Lengua de señas argentina; LSA

Spoken Word	SignWriting
Ukrania	
un-peso	
una-de-la-tarde	
una-hora	
una-vez	
universidad	
uno	
Unquillo	
Uruguay	
Uruguay	

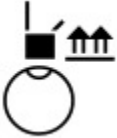
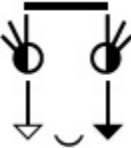
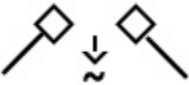
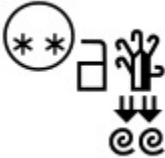
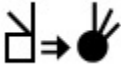

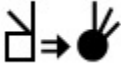
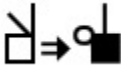
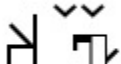



# Lengua de señas argentina; LSA

Spoken Word	SignWriting
V	
vaca	
vacaciones	
valiente	
varicela	
veinte	
veinte	
veinte	
veinte	
veintiseis	

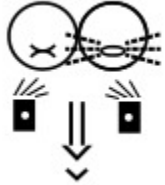



# Lengua de señas argentina; LSA

Spoken Word	SignWriting
veloz	<p>The signwriting for 'veloz' consists of a circle containing an asterisk, a diamond, and a circle with a dot. Below these are two diamonds and a set of three arrows pointing left and right.</p>
veloz	<p>The signwriting for 'veloz' consists of a circle containing an asterisk, a diamond, and a circle with a starburst. Below these are two diamonds and a set of three arrows pointing left and right.</p>
vencimiento	<p>The signwriting for 'vencimiento' consists of a diamond, a square, and a set of three arrows pointing left and right.</p>
vendedor	<p>The signwriting for 'vendedor' consists of two hands with fingers spread, a circle with a horizontal line, and two hands with fingers spread.</p>
vender	<p>The signwriting for 'vender' consists of a hand with fingers spread, a circle with a horizontal line, and a hand with fingers spread.</p>
Venezuela	<p>The signwriting for 'Venezuela' consists of a square, a zigzag line, and a hand with fingers spread.</p>
venir	<p>The signwriting for 'venir' consists of a hand with fingers spread, a square, and a hand with fingers spread.</p>



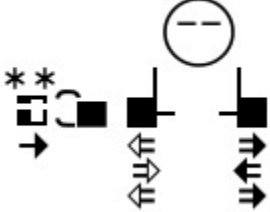

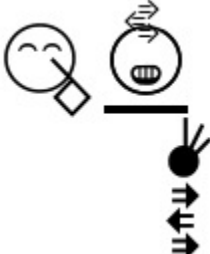

# Lengua de señas argentina; LSA

Spoken Word	SignWriting
venir-abajo-EXCL	
ventana	
ventilador	
ventilador de techo	
ver	
ver	
ver	

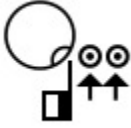
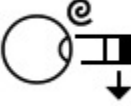
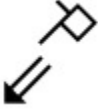
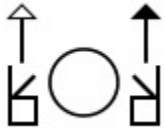

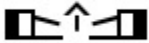



# Lengua de señas argentina; LSA

Spoken Word	SignWriting
ver	
ver internet	
ver-1S-2S-INT	
ver-DUB	
ver-NEG	
verdad	
verdad	
verdulería	

# Lengua de señas argentina; LSA

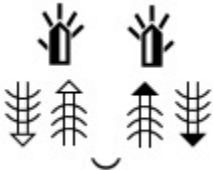



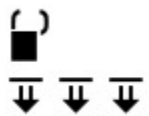

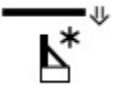

Spoken Word	SignWriting
verdura	
vergüenza	
verter	
veterinaria	
viaje	
vida	
video-reproductor	
viejo	
viejo	
viernes	

# Lengua de señas argentina; LSA

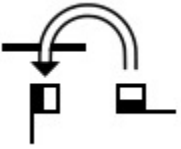
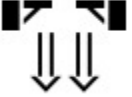





Spoken Word	SignWriting
Villa Allende	
Villa María	
violencia	
violeta	
virtual	
visitar	
viudo	
vivero	
vivir	
vocabulario	





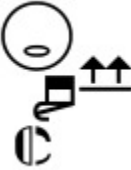

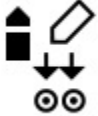

# Lengua de señas argentina; LSA

Spoken Word	SignWriting
vocación	
volcán	
volver	
votación	
W	
Washington	
X	
Y	
ya-está	
ya-está-EXCL	

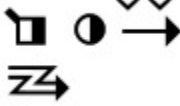





# Lengua de señas argentina; LSA

Spoken Word	SignWriting
yerba	
yerno	
yo	
yo	
yogurt	
Z	
zapatilla	
zapato	
zapato	
zapato	

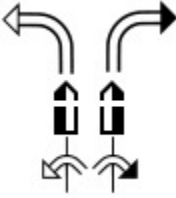
# Lengua de señas argentina; LSA

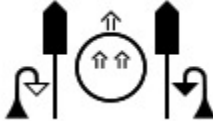
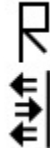
Spoken Word	SignWriting
zapato taco alto	
zoológico	
¿eh?	
ácido	
África	
ángel	
árabe	
árbol	

# Lengua de señas argentina; LSA

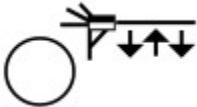
Spoken Word	SignWriting
árbol	
él	
él	
ídolo	
Ñ	
órgano	
último	
único	
único	
útero	